



452 Randolph St, Abington, MA 02351, USA



Split Leg Stirrups

Split Leg Stirrups

800-0342-SL

















Prior to using this or any other type of medical equipment with a patient, it is recommended that you read the Instructions For Use and familiarize yourself with the product.

- Please read and understand all warnings in this manual and on the device itself before using it with a patient.
- The  symbol is designed to alert users to important procedures or safety instructions regarding the use of this device.
- The techniques described in this manual are suggestions from the manufacturer. The attending physician retains the final responsibility for patient care with respect to this device.
- Check the device function before each use. Do not use this device if there are obvious signs of damage or functional issues. Consult manufacturer before reusing.
- This device should only be operated by trained personnel.
- All modifications, upgrades, or repairs must be carried out by an authorized specialist.
- Any serious incidents related to the device should be reported to the manufacturer and the national competent authority where the user is located.



**NEVER EXCEED THE WEIGHT CAPACITY OR IMPROPERLY
DISTRIBUTE THE LOAD ON THE OPERATING ROOM TABLE.**

Symbol	Description	Reference
	Manufacturer	EN ISO 15223-1
	Date of manufacture	EN ISO 15223-1
	Authorized Representative in the European Community	EN ISO 15223-1
	Authorized Representative in Switzerland	EN ISO 15223-1
	Authorized Representative in UK	EN ISO 15223-1
	Importer	EN ISO 15223-1
	Serial Number	EN ISO 15223-1
	Warning	IEC 60601-1
	Medical Device	MDR 2017/745
	Unique Device Identifier	EN ISO 15223-1
	CE Marking	MDR 2017/745
	Use-By Date	EN ISO 15223-1
	Batch Code	EN ISO 15223-1
	Manufacturer's Reference Number	EN ISO 15223-1

Indication for Use:

Split Leg Stirrups are used in a variety of surgical procedures including, but not limited to gynecology, urology, laparoscopy, colorectal, general, and robotic surgery. These devices are capable of being used with a broad patient population as deemed appropriate by medical professionals within hospitals and surgery centers

Intended Use:

The Split leg Stirrups is designed to position and support the patient's foot, lower leg and upper leg in a variety of surgical procedures including, but not limited to short duration procedures that need lithotomy position. These devices are intended to be used by healthcare professionals within the Operating Room setting.

Intended User: Surgeons, Nurses, Doctors, Physicians and/or Healthcare professionals involved in the intended procedure utilizing the device. All staff using or preparing the intended product should be properly trained and familiar with the positioning device before use.

Intended Populations: This device is intended to be used with patients that do not exceed the weight in the safe working load field specified in the product specification section.

Residual Risk:

This product complies with relevant performance, safety standards. However, misuse, device damage, function or mechanical hazards cannot be completely excluded. End users are responsible for ensuring device is securely attached and will operate in a safe manner.

Safety Considerations:

DO NOT USE IF THE PRODUCT SHOWS VISIBLE DAMAGE OR SIGNS OF IMPROPER FUNCTIONING.

Equipment Misuse:

Do not use the product if package is damaged. All modifications, upgrades, or repairs must be performed by a SchureMed authorized specialist.

Safe Disposal:

End users should adhere to all federal, state, regional, and/or local laws and regulations as it pertains to the safe disposal of medical devices and accessories.

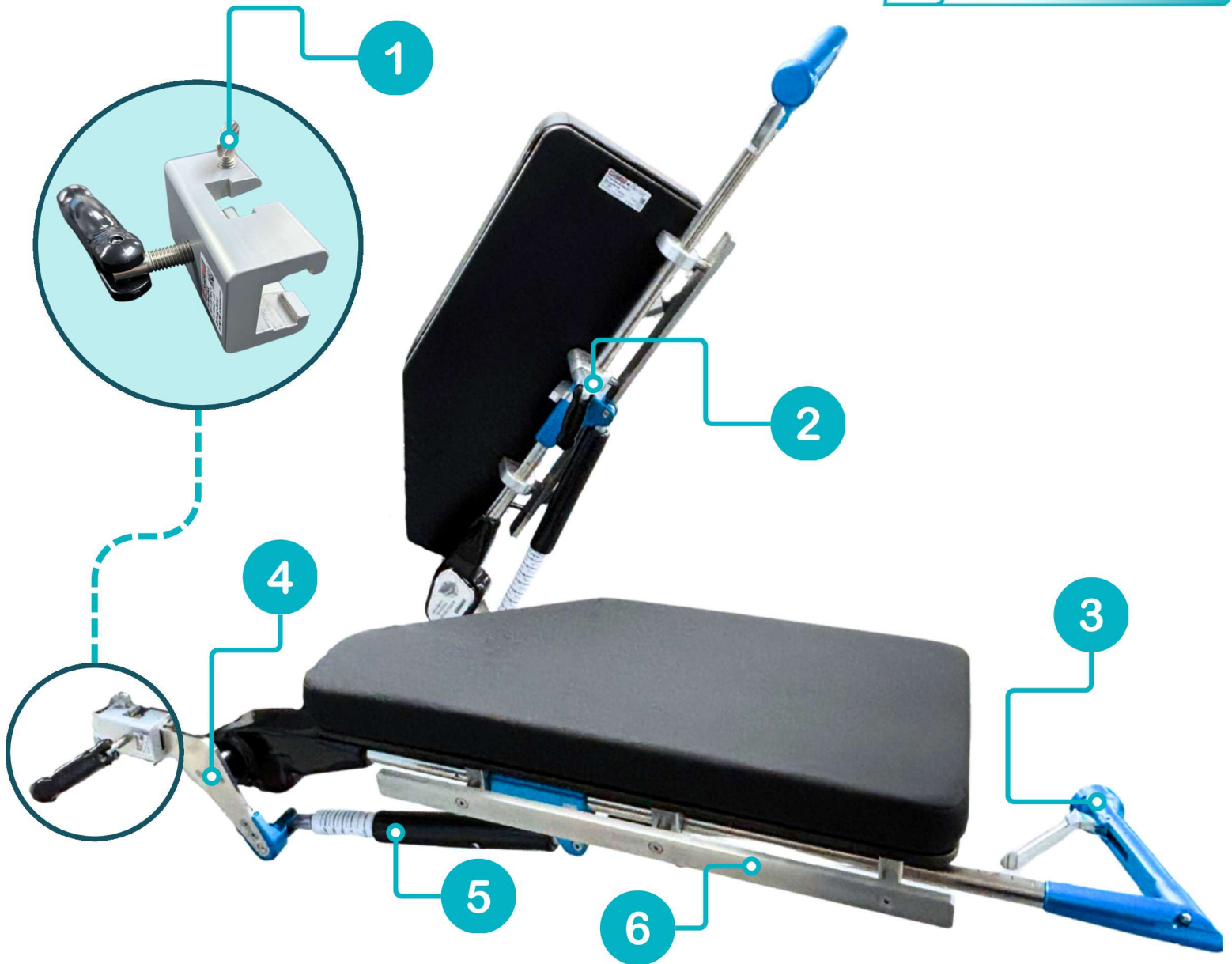

- 1 Clamp Top Screw
- 2 Lateral Rotation Latch
- 3 Lithotomy Adjustment Trigger
- 4 Stirrup Blade
- 5 Locking Gas Spring with Lithotomy Indicator
- 6 Integrated Side Rail

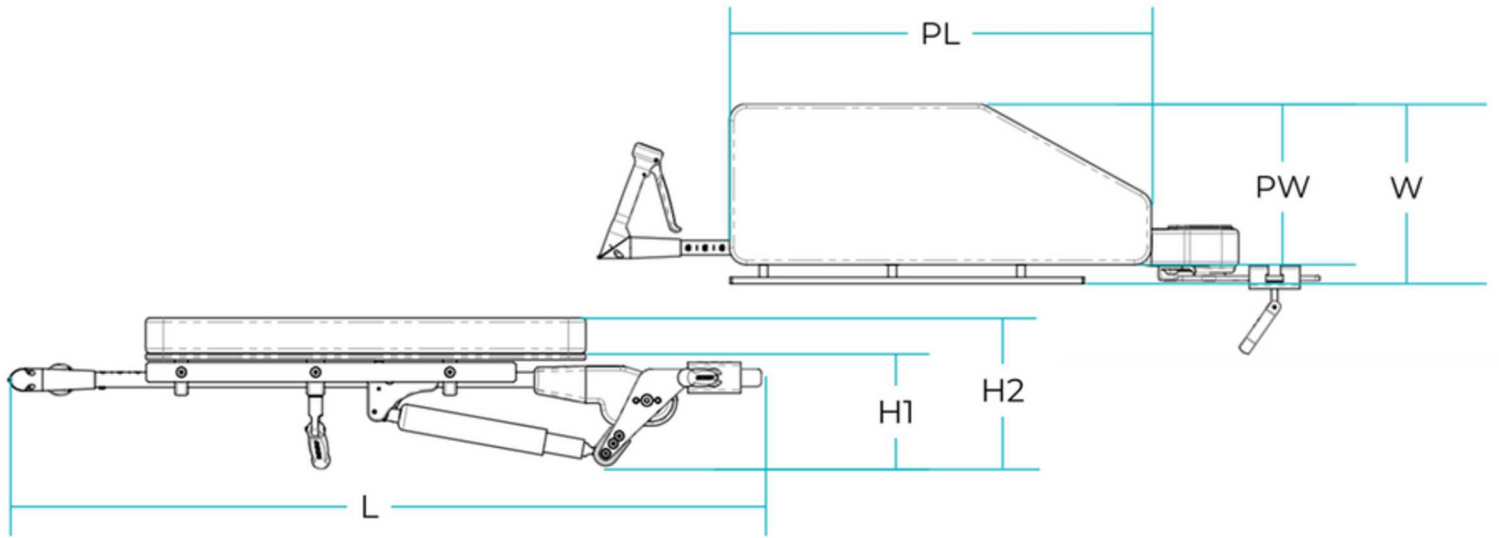

Device Dimensions	Split Leg Stirrups
Length (L)	42.7" +/- 0.5" (108.5cm +/- 1cm)
Width (W)	10.9" +/- 0.5" (27.7cm +/- 1cm)
Height Without Pad (H1)	6.4" +/- 0.5" (16.3cm +/- 1cm)
Height With Pad (H2)	8.4" +/- 0.5" (21.3cm +/- 1cm)
Pad Length (PL)	25" +/- 0.5" (63.5cm +/- 1cm)
Pad Width (PW)	9.5" +/- 0.5" (24.1cm +/- 1cm)
Device Weight Per Stirrup	17.5 lbs +/- 0.5 lbs (8kg +/- .22kg) (with pad)
Range of Motion	-25° to 70° lithotomy range, -8° to 30° adduction to abduction

Storage Specifications	Description
Storage Temperature	-20° F to 140° F (-29° C to +60° C)
Storage Relative Humidity Range	15% to 85%
Operating Temperature	This device is intended to be used in a controlled Operating Room environment.
Operating Relative Humidity Range	

Compatible Product Table:

Accessory Description	Product Number
Split Leg Clamp	800-0228-SL, 800-0228-SL-EU, 800-0228-SL-DEN, 800-0228-SL-UK, 800-0228-SL-JPN, 800-0228-SL-SWISS
Split Leg Footboards	800-0324

System Setup:

1. Lower or remove the leg section from the surgical table. If the table has a removable leg section, press the leg down on the pendant until leg section castings are completely retracted.
2. Attach Split Leg Clamps P/N 800-0228-SL on accessory rails in same location on opposite sides of surgical table with the top screw facing upwards. Tighten the top screw to keep the clamps from moving when inserting the spars.
3. Prior to placing spars into Split Leg Clamps, identify patient's left and right side spar with the table rail extensions facing outward.
4. Insert spar blades horizontally into clamps coming from the foot of the table. Tighten clamps by turning handle to clockwise.
5. Ensure patient is positioned on surgical table in accordance with procedure and surgeon requirements.
6. To achieve appropriate lithotomy and abduction positions, squeeze trigger, adjust to desired position and release to lock.



To prevent patient or operator injury from inadvertent stirrup movement, securely tighten accessory clamp and boot clamp.

Positioning the Patient:

1. To position the patient in Reverse Trendelenburg first install the Split Leg Foot Boards by attaching them to the Split Leg's integrated side rail using SchureMed Stirrup Clamps.
2. Carefully transfer patient onto surgical table per facility procedures.
3. To achieve appropriate lithotomy and abduction positions, squeeze trigger, adjust to desired position and release to lock.
4. Ensure patient is positioned on surgical table in accordance with procedure and surgeon requirements.



Additional positioning devices should be used when using the stirrup in Trendelenburg or reverse Trendelenburg

Device Removal:

1. Loosen clamps and remove stirrups by lifting them out of the clamps.
2. Remove stirrup clamps from side rails.
3. If available, place stirrups and clamps on the storage cart or storage shelf to prevent damage.

Device Maintenance:

1. Make sure that all labels can be read. Replace labels as necessary. Use an alcohol wipe to remove any adhesive residue.
2. Contact SchureMed or an authorized SchureMed Certified Distributor if you need to repair or replace the device.

Cleaning and Disinfection:



- **Clean the device after each use as directed.**
- **Do not submerge the device in liquid.**
- **Use caution in areas where liquid can get into the mechanism.**
- **Position the stirrup parallel to the floor when cleaning to prevent fluids from migrating into product mechanics.**
- **Do not clean the device with bleach or products that contain bleach.**

Wipes:

- Do not use wipes that contain greater than 2% sodium hypochlorite.
- Wipes may contain benzalkonium chloride (up to 0.6% conc.), didecyl dimethyl ammonium chloride (up to 0.6% conc.) and may also contain polyhexamethylene biguanide (up to 0.6% conc.).

Sprays:

When using a spray do not spray the device directly. Spray a clean cloth then wipe the device to clean.

- Sprays may contain up to 2% sodium hypochlorite.
- Sprays may contain up to .2% benzalkonium chloride and up to 0.2% didecyl dimethyl ammonium chloride (quaternary ammonium chloride solution (QACs) and may also contain polyhexamethylene biguanide (up to 0.6% conc.).
- Sprays may contain up to 2% hydrogen peroxide.

Read the cleaning product's directions and follow the instructions on the label. Use caution in areas where fluid migration may occur.

Wipe device with a clean, dry cloth. Be sure that the product is dry prior to reinstalling and storage to avoid damage.

CAUTION: Damage may result if product is cleaned with caustic chemicals or harsh abrasives

ATTENTION: If any SchureMed product is damaged or does not function normally, discontinue use and contact SchureMed or an authorized SchureMed Certified Distributor.

Compliance with Medical Device Regulations



These products are non-invasive, Class I Medical Devices and are CE-marked according to AnnexVIII, Rule 1, of the Medical Device Regulations (REGULATION (EU) 2017/745).

EC Authorized Representative



Emergo Europe

Westervoortsedijk 60
6827 AT Arnhem
The Netherlands

Manufacturing Information



SchureMed

452 Randolph Street,
Abington, MA 02351 USA
Toll Free (888) 724-8752
Ph (781) 982-7001
orders@schuremed.com

UK Authorized Representative



Emergo Consulting (UK) Limited

Compass House, Vision Park Histon
c/o Cr360 - UL International
Cambridge CB24 9BZ
England, United Kingdom

EU & Swiss Importer



MedEnvoy Global B.V.

Prinses Margrietplantsoen
33 - Suite 123
2595 AM The Hague
The Netherlands

CH Authorized Representative



MedEnvoy Switzerland AG

Gotthardstrasse 28
6302 Zug
Switzerland