

Instructions for Use

REF Schure Loc™ XPS 800-0280

Accessories (sold separately)

- 790-0039 Schure Loc™ XPS Adaptor**
- 790-0040 Schure Loc™ XPS Forearm Attachment**
- 790-0056 Schure Loc™ XPS Armboard**
- 790-0057 Schure Loc™ XPS Counter Traction Post**
- 790-0075 Schure Loc™ XPS Elbow/Ankle Positioner**
- 790-0077 Schure Loc™ XPS TKR Positioner**
- 800-0281 Schure Loc™ XPS Sterile Kit**
- 800-0146 Schure Loc™ XPS TKR Boot Liners**



INTENDED USE

Schure Loc™ XPS is used to hold a patient's extremity securely during surgical procedures. Schure Loc™ XPS is mounted to surgical table accessory rail and has full range of motion which can be locked in various positions using one hand trigger. You can intra-operatively adjust patient's limb while maintaining a sterile field. The intended users of this device are medical professionals within hospitals and surgery centers.

GENERAL SPECIFICATIONS

- *Maximum Length: 36" +/- 0.5" (91.4 cm +/- 1 cm)*
- *Maximum Reach: 37" +/- 0.5" (94 cm +/- 1 cm)*
- *Minimum distance from side/rail: 5" +/- 0.5" (12.7 cm +/- 1 cm)*
- *Net Weight, Arm Only: 8 +/- 0.5 lbs. (3.6 +/- .22 kg)*
- *Net Weight with Adapter and Forearm Attachment: 12 +/- 0.5 lbs. (5.44 +/- .22 kg)*
- *Net Weight with Adapter: 10 +/- 0.5 lbs. (4.5 +/- .22 kg)*
- *Range of motion 360° rotation at each joint*
- *Single-person installation*

GENERAL INFORMATION

- *Product not made with Natural Rubber Latex*
- *Device supports 500 lb. (227 kg) proportional patient load (6'4" (193 cm) tall patient per 99% human body model)*
- *Product warranty covers product from manufacturing defects for period of 2 years (Excluding Disposable 800-0281 and 800-0146)*
- *If damaged in shipping, call Customer Service at (888) 724-8763 or (781) 982-7000 to obtain Return Material Authorization number. For product warranty issues, contact Customer Service.*
- *CE marked medical device according to MDR (EU) 2017/745*
- *Product is maintenance-free, check product condition before next use*
- *Life of device is 5 years under normal use*

- Storage device between -4°F to $+86^{\circ}\text{F}$ (-20°C to 30°C)

Other products required for use:

800-0281 Schure Loc™ XPS Sterile Kit, 10 per case (not included)

Schure Loc™ XPS Sterile Kit (forearm pad, self-adherent wrap and sterile drape) is strictly required for proper use of the Schure Loc™ XPS. All products within sterile kit are disposable and single-use only.

800-0146 TKR Boot Liners, 12 per case (not included)

TKR Boot Liner is strictly required for proper use of Schure Loc™ XPS. Liner Pad, within sterile kit, is disposable and single-use only

COMPONENT OVERVIEW



1—Schure Loc™ XPS Articulating Arm

Accessories Sold Separately

- 2**—Schure Loc™ XPS Adaptor (790-0039)
- 3**—Schure Loc™ XPS Forearm Attachment (790-0040)
- 4**—Schure Loc™ XPS TKR Boot Liner (*Disposable–Single use only*) (800-0146)
- 5**—Schure Loc™ XPS Sterile Kit (*Disposable–Single use only*) (800-0281)
 - Sterile Forearm Pad
 - Sterile Self-Adherent Coban Wrap
 - Sterile Drape
- 6**—Schure Loc™ XPS TKR Positioner (790-0077)
- 7**—Schure Loc™ XPS Counter Traction Post (790-0057)
- 8**—Schure Loc™ XPS Armboard (790-0056)
- 9**—Schure Loc™ XPS Elbow/Ankle Positioner (790-0075)

Schure Loc™ XPS is used to hold a patient’s extremity securely during surgical procedures.

Schure Loc™ XPS attaches to any side rails that are within the following dimensions:

Rail Width Size: .23” - .39” (6 mm - 10 mm)

Rail Height Size: .98” - 1.49” (25 mm - 38 mm)

PRODUCT USE WARNINGS



All products used may only be used in sterile condition, except Articulating arm which is used with a sterile cover.



Adaptor, Forearm Attachment and TKR are supplied in a non-sterile condition and must be cleaned and sterilized before first use.



WARNING!

Risk of injury!

Hazard resulting from incorrect use. Be absolutely sure to follow Instructions for Use for your operating table system.



WARNING!

Risk of injury! *Vital functions can be impaired through incorrect positioning. Position patient correctly and maintain continuous observation.*



WARNING!

Risk of injury! *A worn or damaged product/accessory can cause injuries. Only use products/accessories which are in perfect condition.*



WARNING!

Risk of injury! *Maximum load should not exceed appropriate proportion of a patient weighing 500 lbs. (227 kg). Use care with low-maximum load capacity surgical tables that accessory rails are not overloaded. Strictly follow instructions for use for your Operating Table system.*



WARNING!

Risk of injury! *Collisions between accessories, operating table, table top and patient can occur when adjusting or moving operating table or table top or when transferring table top. Observe adjustment procedure and avoid collisions.*



WARNING!

Risk of burning! *Patient to burn hazard due to contact with metal components in device or accessories and/or if resting on wet drapes or electrically conductive padding. Avoid any contact between patient and metallic components; never use moist or wet surgical drapes. Be absolutely sure to comply with manufacturer's operating instructions!*



WARNING!

Risk of injury! Before opening swivel joints, hold patient's limb securely. Make sure all swivel joints are closed after each adjustment procedure.



WARNING!

Risk of injury! Whenever product is mounted and adjusted, there is a WARNING of pinching and shearing to staff, patient and accessories. Always ensure that no one can be subjected to pinching or shearing action or injured in any other way and that accessories do not collide with any nearby objects.



WARNING!

Risk of injury! Patient may be endangered as a result of incorrect use. Follow operating instructions for all accessories.



WARNING!

Risk of mobile operating table tipping over! Product affects center of gravity of mobile operating table. When positioning patient, be absolutely sure to follow Instructions for Use for your operating table system.



WARNING!

Property damage! Do not lubricate or oil articulating arm. It may lead to irreparable damage to functioning of unit.



WARNING!

Property damage! Schure Loc™ XPS is used to support patient arm. No other additional forces may act on Schure Loc™ XPS.



WARNING!

Property damage! During surgery, Schure Loc™ XPS must be covered by a sterile cover to protect it against from liquids.



WARNING!

Property damage! High temperatures, moisture and humidity can damage product. Protect product against moisture and humidity, clean by wipe disinfection only. Do not store close to radiators and protect from high solar radiation. Do not expose product to large impacts and vibrations, product is not designed for impulse loads.



WARNING!

Risk of infection! Do not use sterile set when packaging of sterile set is damaged.

ASSEMBLY

All products used, except *articulating arm*, which is used with a sterile cover, may only be used in sterile condition.

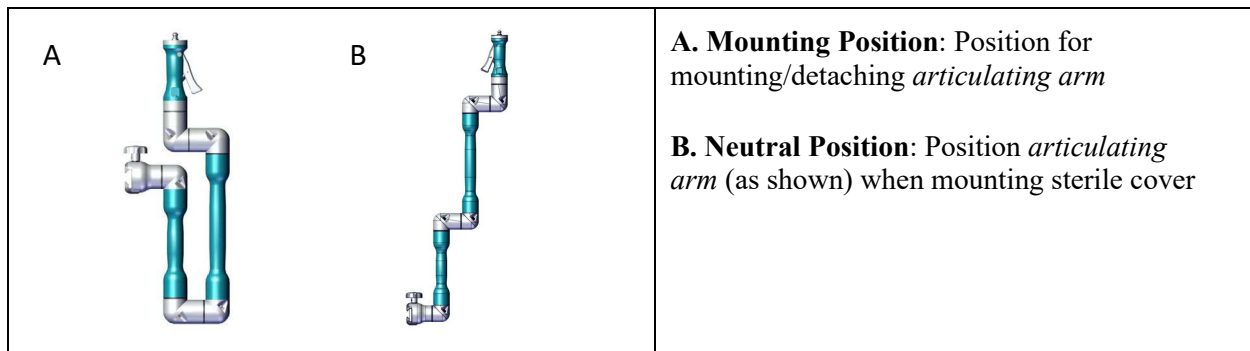

Mounting Schure Loc™ XPS onto Surgical Table



Articulating arm must be in position (1) when attaching and detaching unit from surgical table rail.

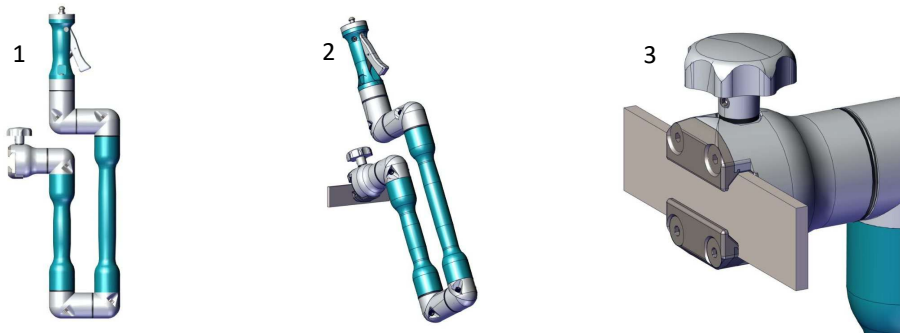

Mounting Articulating Arm to Table

- Place *articulating arm* in mounting position. See (1).
- Verify mounting knob is facing upward and in loose unlocked position. See (2).
- Place clamp on accessory rail of surgical table in seat plate area between patient hip and knee
- Tighten clamp by turning mounting knob to the right. See (3).

You must clamp directly to side rail to fix *articulating arm* to rail securely.



Check to ensure clamp is properly and safely tightened to prevent potential injury to patient or product damage.

Draping Schure Loc™ XPS and Mounting the Adaptor, Armboard, Counter Traction Post, Elbow/Ankle Positioner, TKR and Forearm Attachments

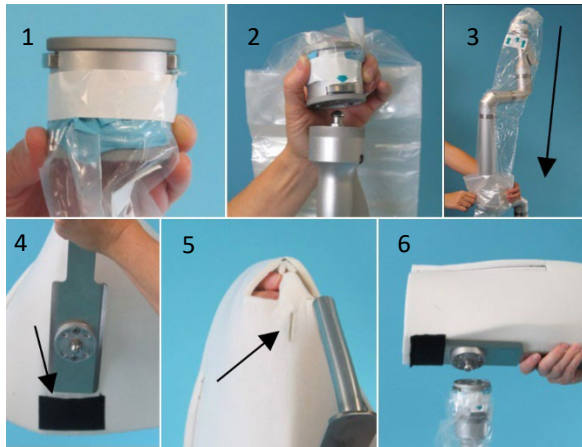

Pocket

Handle Slot

! Position Schure Loc™ XPS articulating arm in neutral position when draping (See instructions for Mounting Schure Loc XPS™ onto Surgical Table)

- 1. Tape drape to sterilized Schure Loc™ XPS Adaptor so that half the tape is on drape and remainder is on adaptor as shown in (1).*
- 2. Attach Adaptor to articulating arm as shown in (2). Twist to lock fully into place.*
- 3. Pull drape down over Adaptor and to accessory rail to completely cover Articulating Arm as shown in (3).*
- 4. Slip end of forearm attachment into pocket at bottom of Forearm Pad. Then slide handle into handle slot as shown in (4) and (5).*
- 5. Attach Schure Loc™ XPS Forearm attachment to Adaptor and rotate slightly so it is properly attached. See (6).*
- 6. Attach Schure Loc™ Armboard, Counter Traction Post, Elbow/Ankle Positioner and TKR and rotate slightly so it is properly attached (see Disassembly).*

Placing and Securing Patient's Arm

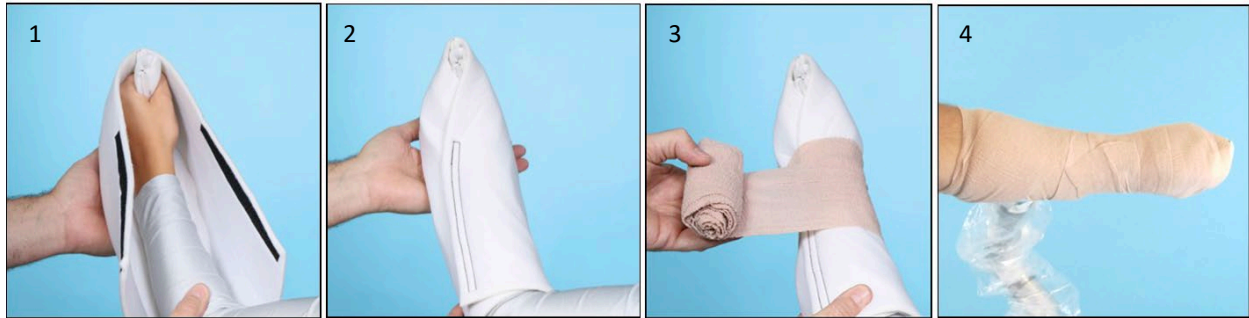

7. Place patient arm into Forearm Pad, ensuring patient's fingers wrap around Forearm Attachment Handle and wrap pad snugly around patient arm. See (1) and (2).
8. Using self-adherent wrap, secure patients arm to forearm attachment by wrapping entire assembly. Be sure to secure hands and fingers with wrap. See (3) and (4).

Do not wrap Adaptor in order to allow for intra-operative detachment.

Adjusting Articulating Arm



WARNING!

Risk of injury due to unintended movements downwards!

When squeezing trigger, swivel joints are released and Schure Loc™ XPS can be moved. Due to its own weight and weight of patient, it will fall downward. Before squeezing trigger, firmly hold Schure Loc™ XPS with both hands. After every adjustment process, ensure trigger is released and locks Schure Loc™ XPS into place. Check that no foreign bodies (e.g. sterile cover, glove) are pinched.



WARNING!

Excessive load may cause mechanism to jam slightly. In this case, take load off Schure Loc™ XPS, if necessary, detach arm rest and push in handle with increased force to open joints.



Mount Schure Loc™ XPS in seat plate area

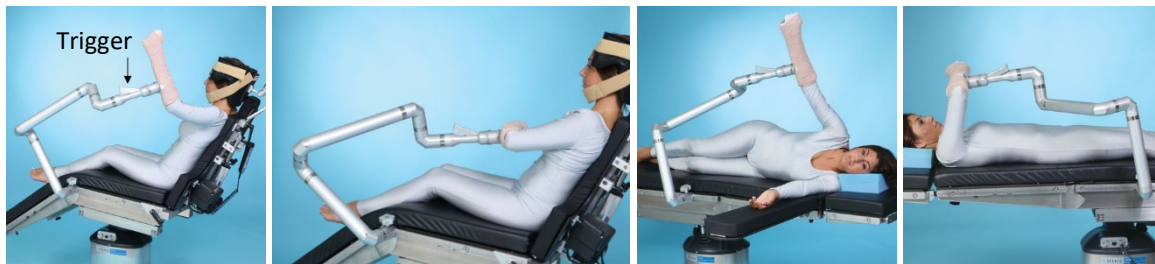

Adjusting the Articulating Arm

1. *Release Schure Loc™ XPS upwards*
2. *Squeeze Trigger as far as it will go and hold it. All swivel joints are released, and Schure Loc™ XPS can move freely.*
3. *Swivel articulating arm to the desired position*
4. *Release Trigger and Schure Loc™ XPS swivel joints will be locked*

OTHER ACCESSORY INSTRUCTIONS

790-0056 Armboard

1. *Place patient's arm in center of pad, attach strap to velcro strap on bottom of armboard and wrap it around arm and attach strap to velcro strap on the bottom of board*

790-0057 Counter Traction Post

1. *Articulate Schure Loc™ XPS to desired position, wrap patient's arm around post with elbow pointing up.*
2. *Articulate Schure Loc™ XPS to desired position, rest patient bottom foot on post*

790-0075 Elbow/Ankle Positioner

1. *Articulate Schure Loc™ XPS to desired position, wrap patient's arm inside cradle with elbow pointing up*
2. *Articulate Schure Loc™ XPS to desired position, rest patient foot in cradle*

790-0077 TKR Positioner

1. *Drape surgical table*
2. *Articulate Schure Loc™ XPS to desired position, TKR boot must be resting on table*
3. *Line boot with our sterile TKR Boot Liner #800-0146 (sold separately 12/cs)*
4. *Insert foot into boot, secure foot by wrapping sterile coban*

DISASSEMBLY

During surgery, you can check range of motion and maintain sterile field by removing forearm attachment, armboard, counter traction post, elbow/ankle positioner or TKR from adaptor. Now their limbs can move independently without Schure Loc™ XPS.

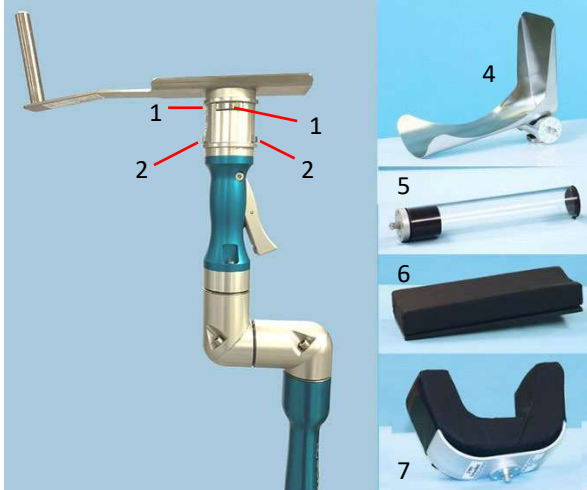

Removing Adaptor, Forearm Attachment, Armboard, Counter Traction Post, Elbow/Ankle Positioner and TKR

- To remove Forearm Attachment, simultaneously press in both top release buttons (1) of adaptor and Forearm Attachment will release upward
- To remove Armboard (6), Counter Traction Post (5), Elbow/Ankle Positioner (7) or TKR (4) simultaneously press in both top release buttons (1) of Adaptor and accessories will release upward
- To remove Adaptor, simultaneously press in both bottom release buttons (2) of Adaptor and Adaptor will release from articulating arm

Detaching Schure Loc™ XPS From Operating Table



Articulating arm must be in position (1) when detaching unit from surgical table rail.

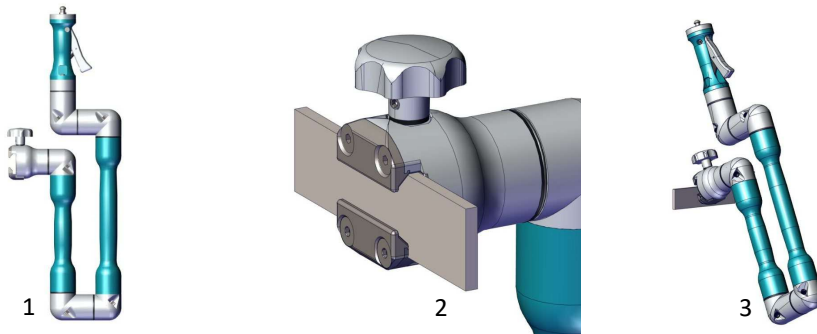

Detaching Schure Loc™ XPS

!Place articulating arm in mounting position.

1. Loosen clamp by turning mounting knob to left
2. Move articulating arm in an upward motion to remove from accessory rail
3. Remove product from accessory rail, clean and store

CLEANING AND DISINFECTION



WARNING!

Product must be cleaned and wipe or spray disinfected after every use.



WARNING!

Clean and sterilize Adaptor 790-0039, Forearm Attachment 790-0040 and TKR Positioner 790-0077 before initial use and after every use.



WARNING!

Do not submerge or use washer cleaning for the Schure Loc XPS 800-0280 or Adaptor 790-0039 or Forearm Attachment 790-0040 or TKR Positioner 790-0077 or Traction Post 790-0057 or Armboard 790-0056 or Elbow/Ankle Positioner 790-0075.



WARNING!

Risk of infection!

Particles of grime may become encapsulated and lead to product not reaching desired germ-reduction after disinfection. Before disinfection, product must be cleaned thoroughly of contamination and encapsulated particles of grime and then be dried.



WARNING!

Risk of infection!

Do not use sterile set when packaging of sterile set is damaged.



WARNING!

Risk of infection!

If articulating arm is used in areas with varying hygienic requirements, there is a risk of infection. Ensure that articulating arm is always in sterile area while being used.



WARNING!

Improper cleaning and disinfection can cause property damage!

Perform visual and functional inspections after each cleaning and disinfection process.



WARNING! *Do not reuse device if there are obvious signs of damage or functional issues. Consult manufacturer before reusing.*



WARNING! Improper cleaning and disinfection can cause property damage!

Do **not** use following products for cleaning and disinfection:

- Products containing alcohol
- Halogenides
- Dehalogenating compound
- Products that may scratch the surface
- Water containing iron particles
- Cleaning sponges containing Iron
- Products containing hydrochloric acid

Use approved detergents and disinfectants only. Use a soft, lint free cloth or a soft nylon brush to clean product.



CAUTION!

Improper cleaning and disinfection can cause property damage!

Use only as much detergent and disinfectant as required. Thoroughly wipe off any excess detergent and disinfectant with a damp, soft cloth. Avoid surface drying of excess detergent and disinfectants.

CLEANING INSTRUCTIONS

- Disassemble Schure Loc™ XPS System into separate parts and clean thoroughly before each use
- Wipe clean and disinfect with a hospital grade disinfectant, enzymatic neutral pH detergent solution, or hydrogen peroxide based solution
- Wipe each part completely dry with a clean, lint-free cloth
- *Based on information provided by the Healthcare Infection Control Practices Advisory Committee (HICPAC), the Center for Disease Control (CDC), the National Center for Biotechnology Information (NCBI) and the U.S. National Library of Medicine.

STEAM STERILIZATION

Use only for Adaptor 790-0039, Forearm Attachment 790-0040 and TKR Positioner 790-0077.
Wrap using envelope method or accepted wrap method at your facility.

Pre-Vacuum

Wrapped Instruments

Set Temperature at 132°C (270°F)

Full Cycle Time: 6.5 minutes

Dry Time: 40 minutes

DISPOSAL

- **General** - Prevent infection by cleaning and disinfecting product before disposal
- **Packaging** - Dispose packaging material via household waste according to national requirements
- SchureMed accepts back used or retired products - or dispose of product in accordance with national requirements











USER NOTICE

Any serious incident that has occurred in relation to the device should be reported to the manufacturer and the competent authority of the Member State in which the user and/or patient is established.

eIFU Language Versions

To download and print the Instructions for Use, please go to www.schuremed.com

Symbol Glossary

Symbol	Title
	Manufacturer
	Date of manufacture
	Authorized Representative in the European Community
	Authorized Representative in the Swiss
	Importer
	Serial Number
	Warning
	Medical Device
	Unique Device Identifier
	CE Marking
	Single Patient Use



SchureMed (081001460)

452 Randolph Street, Abington, MA 02351 USA

Toll Free (888) 724-8763 | Ph (781) 982-7000 | Fax (781) 982-7001 | orders@schuremed.com

